

Double-Ended Cordsets  
**BCC M324-M414-3E-304-VX44T2-030**  
**Order Code: BCC05C8**

**BALLUFF**

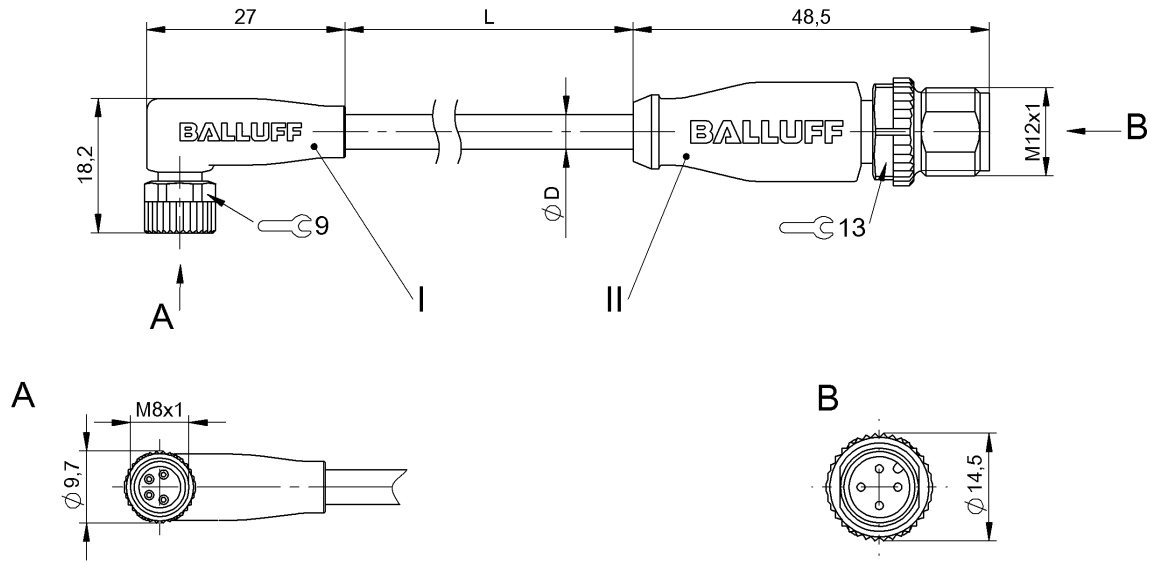

**Basic features**

Approval/Conformity	CE cULus WEEE
---------------------	---------------------

**Electrical connection**

Bending radius min., fixed cable	5 x D
Bending radius min., flexible cable	10 x D
Cable	PVC Yellow, 3 m
Cable diameter D	5.00 mm ±0.15 mm
Cable, bending cycles min.	2 mil.
Conductor cross-section	22 AWG
Connection 1	M8x1-Female, angled, 4-pin, A-coded
Connection 2	M12x1-Male, straight, 4-pin, A-coded
Number of conductors	4
System	Molded/Molded

**Electrical data**

Cable rated voltage AC max.	300 V
Cable rated voltage DC max.	300 V
Operating voltage Ub	60 VDC / 60 VAC
Rated current (40 °C)	4.0 A

**Remarks**

Bulk cable approval per UL-AWM Style 2661 & CSA AWM I/II A/B  
 Enclosure rating per IEC 60529 or 20653, only in screwed state with the associated mating piece.

**Environmental conditions**

Cable temperature, drag chain	-5...60 °C
Cable temperature, fixed routing	-40...105 °C
Cable temperature, flexible routing	-5...105 °C
IP rating	IP67, IP69K/IP67, IP68, IP69K

**Interface**

Switching output	Complementary
------------------	---------------

**Material**

Cable jacket, material	PVC
Material contact carrier	PUR/PUR
Material contacts	Bronze/Brass
Material cover nut	Die-cast zinc or nickel plated brass/Die-cast zinc
Material grip	PUR/PUR

**Mechanical data**

Cable jacket, color	Yellow
Cable length L	3.00 m
Horizontal travel permitted, drag chain	5 m
Tightening torque pigtail	0.4 Nm/0.6 Nm
Traverse speed max., drag chain	200 m/min
Vertical travel permitted, drag chain	2 m at 5 m/s <sup>2</sup>

## Connector Drawings

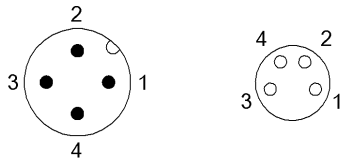

II	I
PIN 1: brown	PIN 1: brown
PIN 2: white	PIN 2: white
PIN 3: blue	PIN 3: blue
PIN 4: black	PIN 4: black

## Wiring Diagrams

